

CITADEL ENGINEERING COMPANY® - TRADEMARK

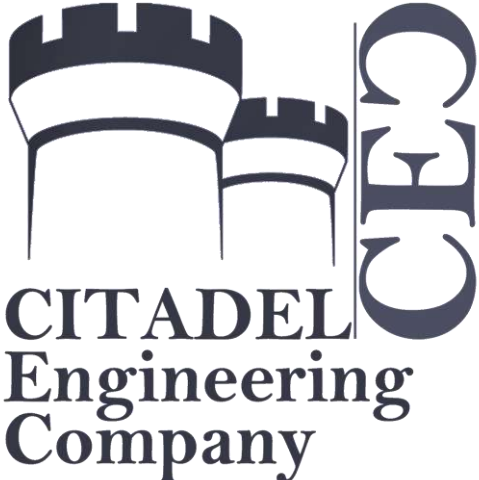

REGISTERED
TRADEMARK

GLOBAL OFFICES CITADEL ENGINEERING COMPANY



WHERE CITADEL ENGINEERING COMPANY WORKED

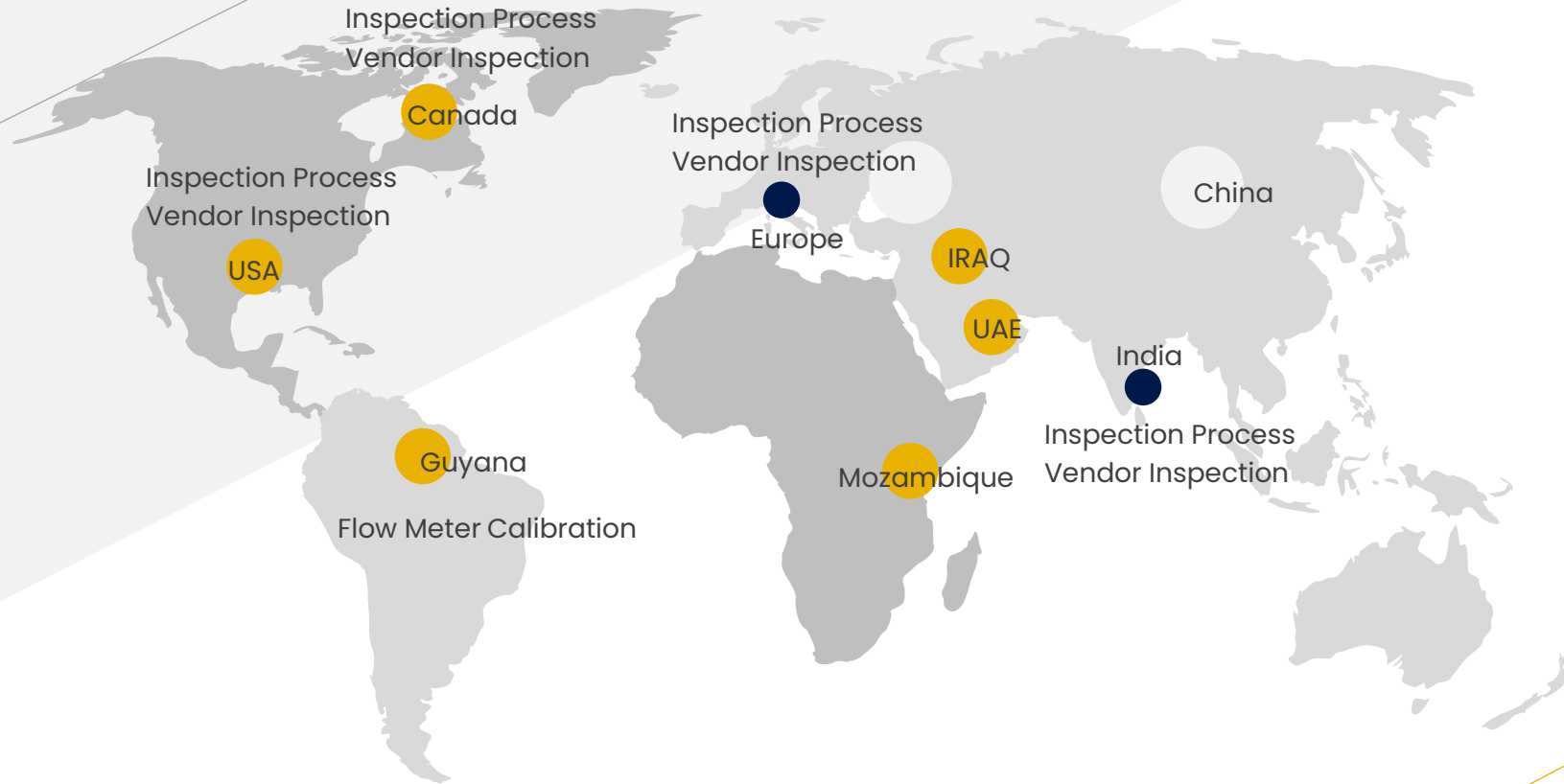



CERTIFICATES & ACCREDITATION



J. Gerardo Uria
 Senior Director, Membership & Events
 API
 Global Industry Services
 200 Massachusetts Avenue, NW
 Suite 1102
 Washington, DC 20001-5571
 202-682-8522

June 30, 2020

Shahriyar Majlesein
 CEO
 Citadel Engineering Company
 136 E. South Temple, Suite 1400
 Salt Lake City, UT 84111

Dear Shahriyar,

Welcome to API!

Citadel Engineering Company has joined over 600 members involved in all sectors of the oil and natural gas industry. With this broad base of support, the American Petroleum Institute is the only national trade association that represents all aspects of the industry, enabling us to be a powerful voice for your company.

API membership provides Citadel Engineering Company with representation before key legislative and regulatory bodies, and access to widely recognized standards development and certification programs. We are confident you will find great value in your association with API, as well as in the performance of API staff and its committees.

As an API member, Citadel Engineering Company is important to us, and we want to ensure that all of your employees benefit from your organization's membership in API. The executive contact will receive via e-mail the weekly Executive Update from API President Mike Sommers. In addition, anyone from your company ordering API publications or participating in our programs and services will receive the API member discount. We will also post a link to your organization's website under "Membership" on www.api.org.

All of us at API thank you and look forward to working with you in support of a strong, viable U.S. oil and natural gas industry. Should you need further information, please contact us at your convenience.

Sincerely,

J. Gerardo Uria

An equal opportunity employer



CERTIFICATES & ACCREDITATION

ANNUAL MEMBERSHIP CERTIFICATE 2021



Head Office:
Rue du Commerce 20-22
1000 Brussels
www.tic-council.org
VAT no.: BE 0724881295

We hereby certify that

Citadel Engineering Company (CEC)

Head office:
South Temple, Suite 1400
Salt Lake City, UT
84111
USA

is a member in good standing of

TIC Council

Brussels, February 2021

Director General

TIC Council
Rue du Commerce 20-22, 1000 Brussels, Belgium | +32 2 880 2137
secretariat@tic-council.org | www.tic-council.org
VAT: 860724881295 | Transparency Register No.: 840667012559
Formerly known as IFIA and CEIC

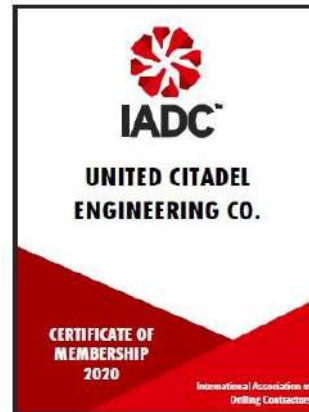



GREATCITADEL
YOU CAN'T STOP SUPPLY

2020

PARTNERSHIP

FROM 2021, GREAT CITADEL BECOME
CHANNEL PARTNER OF SO MANY
COMPANIES AND INDUSTRIES

**BAKER
HUGHES**



Additel

GREAT CITADEL COMPANY

Company decided to open new entity as
Great Citadel as Sister Company of Citadel
for Supply and Services

2021

Masoneilan
Process Controlled

HASKEL





GREATCITADEL
YOU CAN'T STOP SUPPLY

ABB

—
**VALUE
PROVIDER**

GAS METERING SKID

FIRST COMPANY THAT CALIBRATION OF THE GAS METERING SKID IN IRAQ

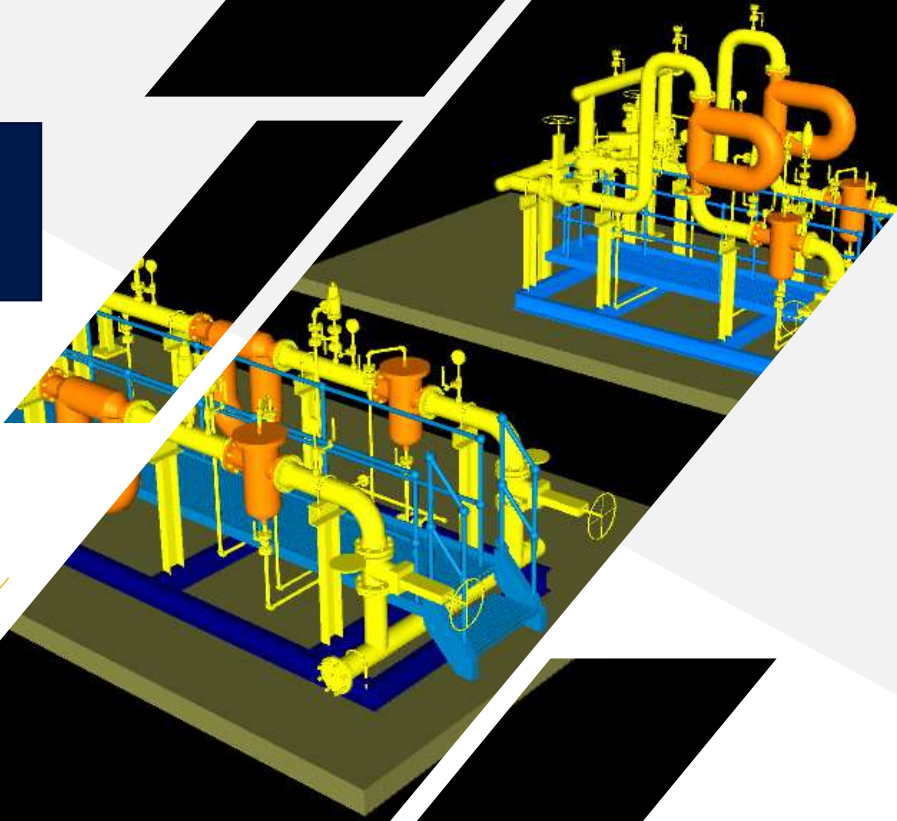
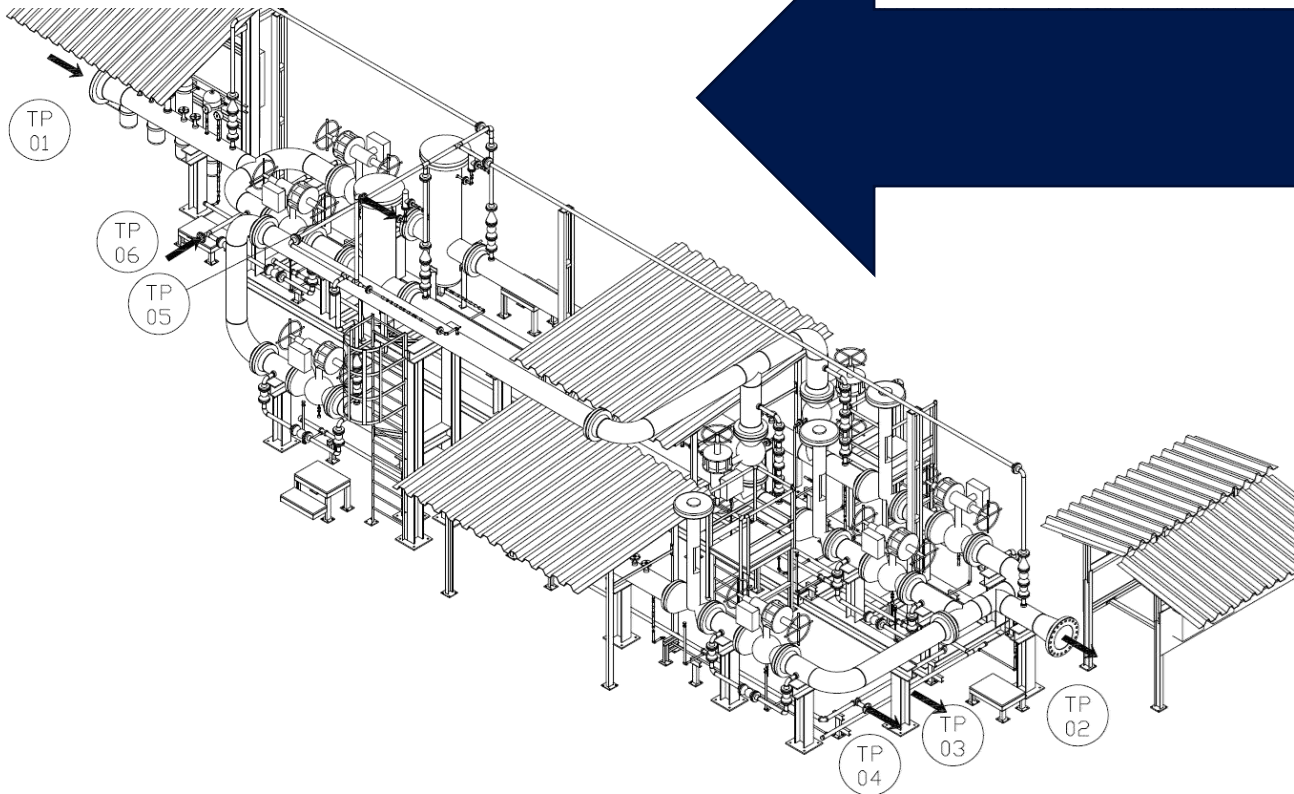



—
**VALUE
PROVIDER**



ABB Metering Modules are bundled, pre-tested solutions that help improve the accuracy of fiscal metering, blending and pressure reduction for your oil and gas products.



PIPE PROVER CALIBRATION

Inspection, Calibration & Maintenance
Location: Basra, IRAQ

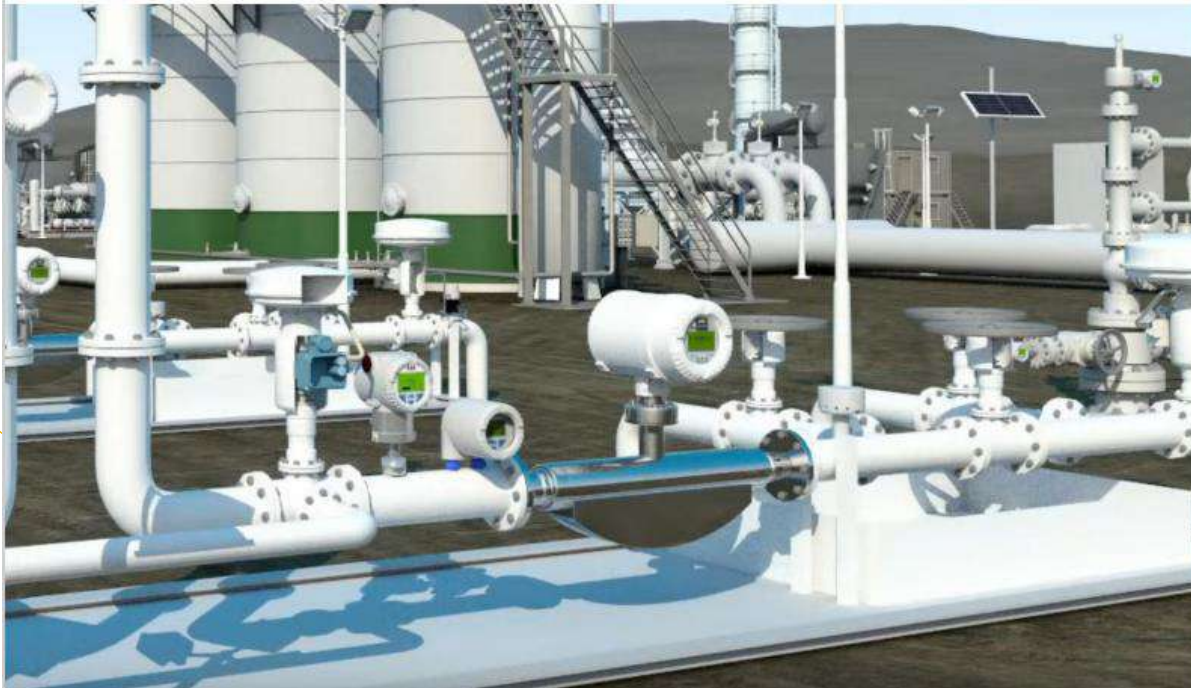

FLOW METER CALIBRATION

Coriolis Flow Meter Calibration X4
Master Metering Dynamic Method
Location: KRG, IRAQ



MASTER METER PROVING

Coriolis Flow Meter Calibration & Verification



PIPE PROVER CALIBRATION

Calibration, Inspection and Maintenance of the Prover





CUSTOMIZE FLOW COMPUTER

Fabrication of the Customize Flow
Computer

Batch Controller



COMMISSIONING OF THE METERING SKID

Coriolis Flow Meter X2 | Location: IRAQ, KRI



SAMPLING SYSTEM CANS

Fabrication of the Sampling System Cans and Maintenance of the Sampling Units





FABRICATION OF THE ULTRASONIC FLOW METER SKID

Engineering, Fabrication,
Installation and Commissioning of
the Ultrasonic UFM Skid

Location: IRAQ, KRI

ABB FLOW COMPUTER PANEL FABRICATION

Engineering, Supply, Installation and Commissioning



FABRICATION OF PIPE PROVER

Engineering, Design, Fabrication, Testing, Inspection of
Directional and Bi-Directional Pipe Prover



TANK PROVER CALIBRATION



REPAIR & MAINTENANCE

POSITIVE DISPLACEMENT METERS AND 4 WAY VALVES



FABRICATION OF STRAIGHTENER

ENGINEERING, DESIGN AND FABRICATION



DESIGN THE MASTER METERING SKID



SAMPLING SYSTEM UNIT

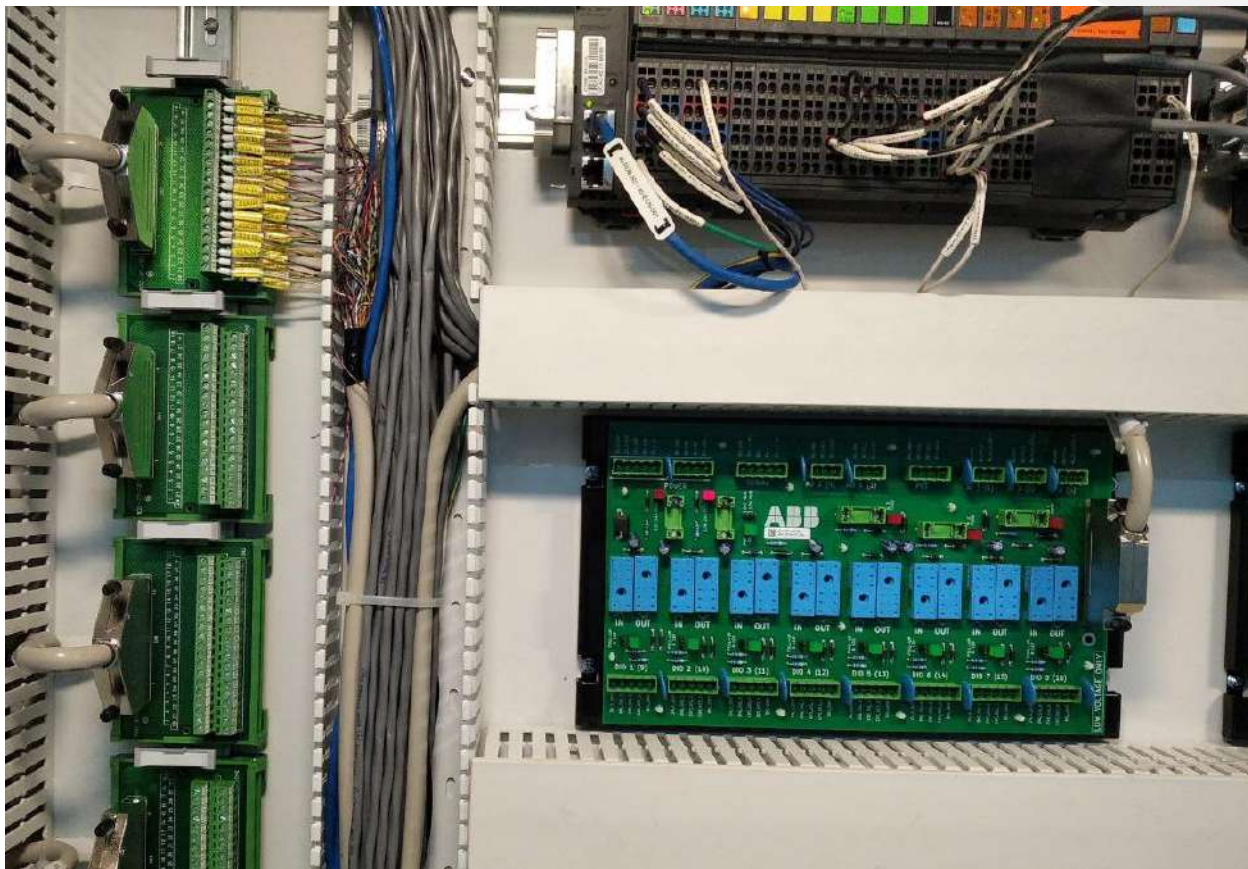

ORIFICE PLATE FABRICATION



PROVING IN KUWAIT



FABRICATION OF WATER DRAW PACKAGE

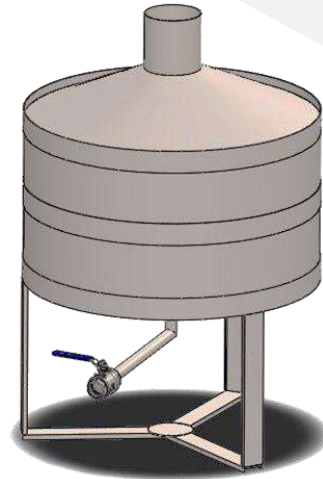

PROVER COATING INSPECTION

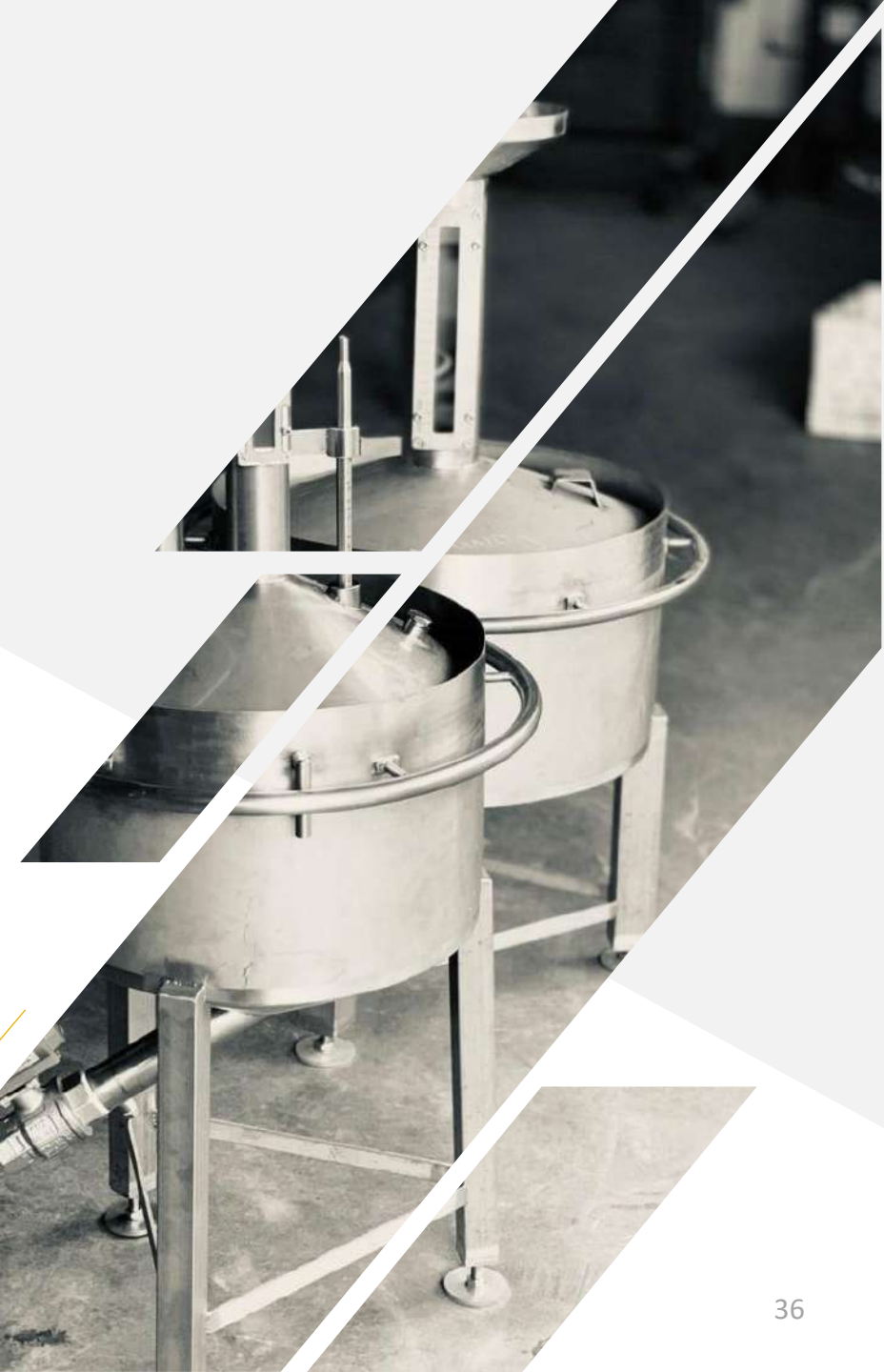

UFM FLOW METER REPAIR & DIAGNOSTICS (FMC)

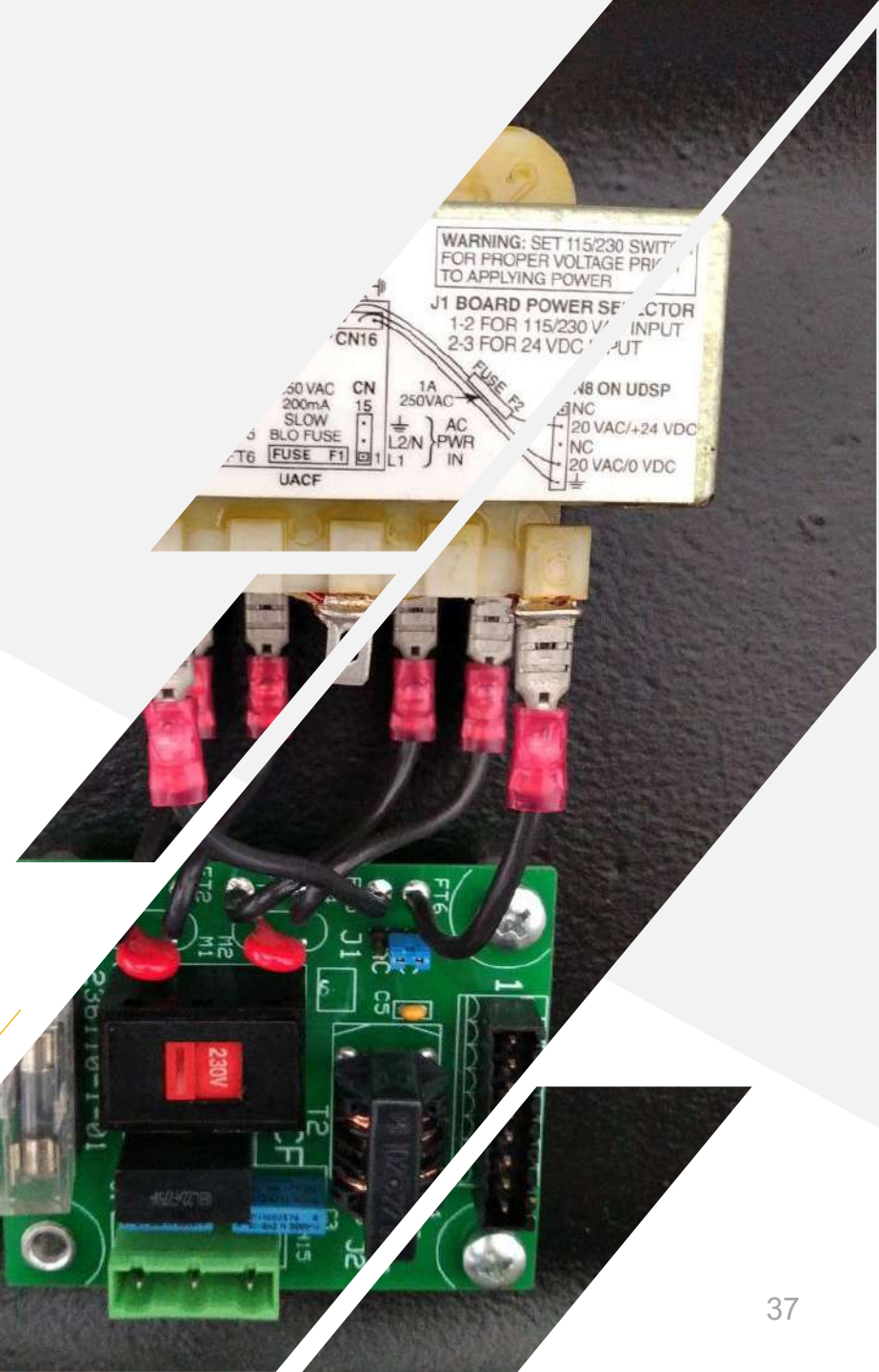
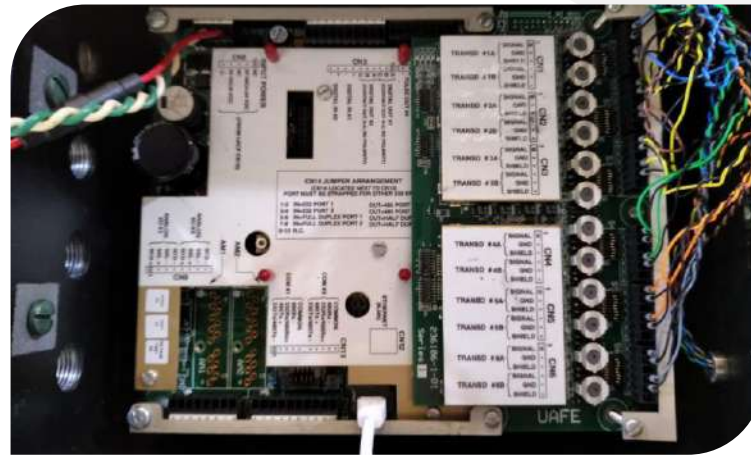

HYGIENIC FLOW METER CALIBRATION



MOV AND CV REPAIR & MAINTENANCE



PORTABLE CALIBRATION FACILITY



PD METER CALIBRATION WITH PETROLEUM PRODUCTS



PIPE PROVER MAINTENANCE & PAINTING



PROVER INSPECTION, CALIBRATION AND MAINTENANCE



THANK YOU

